

Mini, Small, Medium, Large

U. S. Suggested Retail Price List
Nov-21

Phone: 260-665-2769

Fax: 260-665-3047

Email: iim@mobility-usa.com

www.mobility-usa.com

Quote: _____

P.O. _____

Bill To

Dealer: _____ Contact: _____

Address: _____

City: _____ State: _____ Zip: _____

Phone: _____ Fax: _____

Email: _____ Mark For: _____

Ship To Same as Bill To _____

Dealer: _____ Contact: _____

Address: _____

City: _____ State: _____ Zip: _____

Phone: _____ Fax: _____

Email: _____ Mark For: _____

Grillo Features and Specifications Mini, Small, Medium, Large



- **Quick Adjustment** - Grillo adjusts easily and tool-free for user growth, transportation, or multiple patient use.
- **Easy Transport** - In just one motion, Grillo folds into a small compact unit easy to transport. No tools required.
- **Exclusively-Designed Wheels** - Grillo wheels come standard with anti-rollback, independently adjustable tension drag, and brakes. The wheels are suitable for indoor and outdoor use.
- **Chest & Pelvic Supports** - Padded and adjustable in angle, height, inclination, and circumference. The chest and pelvic supports work independently.
- **Ergonomic Harness** - The harness supports the user if necessary without generating pressure and is breathable, adjustable, and removable.
- **Measurement Bars** - allow for quick, easy, and accurate adjustment.
- **Grillo** - has the widest range of height adjustment on the market.

Grillo Frame Options

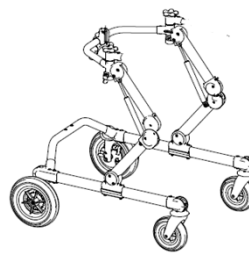
Part Number	Description	Price
Every Frame requires pelvic support hardware, pelvic rings, ergonomic harness, horizontal bars		
____ GRA-MN	Grillo Anterior Frame Mini	\$1,870.00
____ GRP-MN	Grillo Posterior Frame Mini	\$1,870.00
____ GRA-S	Grillo Anterior Frame Small	\$1,970.00
____ GRP-S	Grillo Posterior Frame Small	\$1,970.00
____ GRA-M	Grillo Anterior Frame Medium	\$2,260.00
____ GRP-M	Grillo Posterior Frame Medium	\$2,260.00
____ GRA-L	Grillo Anterior Frame Large	\$2,810.00
____ GRP-L	Grillo Posterior Frame Large	\$2,810.00



Support Options Requires PELVIC SUPPORT HARDWARE, RINGS, ERGONOMIC HARNESS



Part Number	Description	Price	
GR103-MN	Mini Pelvic and Chest Support Hardware & Ring Combo can be used on Mini and Small Frame	\$1,170.00	
HAS TO BE SIZE OF FRAME - REQUIRES CHEST RING			
GR925-MN	Mini Chest Support Hardware	\$140.00	
GR925-S	Small Chest Support Hardware	\$140.00	
GR925-M	Medium Chest Support Hardware	\$140.00	
GR925-L	Large Support Hardware	\$140.00	
MAY SELECT UP TO ONE SIZE SMALLER FROM FRAME SIZE			
GR303200	Chest Ring Size Mn each support is 11.5" long	\$350.00	
GR303194	Chest Ring Size Sm each support is 13" long	\$350.00	
GR303192	Chest Ring Size Md each support is 15" long	\$350.00	
GR303190	Chest Ring Size Lg each support is 18" long	\$350.00	
HAS TO BE SIZE OF FRAME - REQUIRES PELVIC RING			
GR924-MN	Mini Pelvic Support Hardware	\$330.00	
GR924-S	Small Pelvic Support Hardware	\$330.00	
GR924-M	Medium Pelvic Support Hardware	\$330.00	
GR924-L	Large Pelvic Support Hardware	\$330.00	
MAY SELECT UP TO ONE SIZE SMALLER FROM FRAME SIZE			
GR303199	Pelvic Ring Size Mn each support is 11.5" long	\$350.00	
GR303193	Pelvic Ring Size Sm each support is 13" long	\$350.00	
GR303191	Pelvic Ring Size Md each support is 15" long	\$350.00	
GR303189	Pelvic Ring Size Lg each support is 18" long	\$350.00	
MAY SELECT UP TO ONE SIZE SMALLER OR LARGER FROM FRAME SIZE			
GR930-MN	Ergonomic Harness Mn 10.5" - 18.5" requires GR924	\$440.00	
GR930-S	Ergonomic Harness Sm 10.5" - 18.5" requires GR924	\$440.00	
GR930-M	Ergonomic Harness Md 15" - 25" requires GR924	\$440.00	
GR930-L	Ergonomic Harness Lg 15" - 25" requires GR924	\$440.00	

Bars to attach Handle Options Required HAS TO BE SIZE OF FRAME



GR835-MN	Horizontal Bars Mn only 6.5" long	\$160.00	
GR835-S	Horizontal Bars Sm 8.5" long	\$160.00	
GR835-ML	Horizontal Bars Md, Lg 10.5" long	\$170.00	

Handle Options





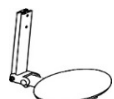

.LO

Part Number	Description	Price	
GR927-MN	Posterior Hand Grips Mn only	\$110.00	
GR927	Posterior Hand Grips Sm, Md, Lg	\$110.00	
GR926-MN	Anterior Handlebar Mn requires GR-HW-MN	\$120.00	
GR926-S	Anterior Handle Bar Sm requires GR-HW	\$120.00	
GR926-M	Anterior Handle Bar Md requires GR-HW	\$170.00	
GR926-L	Anterior Handle Bar Lg requires GR-HW	\$170.00	
GR939	Ergonomic Handles Mn, Sm, Md, Lg requires GR-HW	\$190.00	
GR-HW-MN	Multi Axis Hardware Mn only	\$90.00	
GR-HW	Multi Axis Hardware Sm, Md, Lg	\$90.00	
GR809-MN	Arm Supports Mn only 7" long 4" wide requires GR-HW-MN	\$600.00	
GR809-S	Arm Supports Sm 6" long 3.5" wide requires GR-HW	\$700.00	
GR809-M	Arm Supports Md, Lg 7.5" long 4" wide requires GR-HW	\$750.00	
<u>Description:</u> Works with Anterior and Posterior. Adjustable in height, direction, depth, tilt, and inclination.			
GR943-MNS	Arm Straps Mn, Sm (pair)	\$50.00	
GR943-ML	Arm Straps Md, Lg (pair)	\$50.00	
GR32707	Elbow Stop Sm, Md, Lg 4"x3" padded elbow stop(pr) requires GR809-Sm, Md, Lg	\$420.00	
GR50048	Elbow Stop Cover with Gel Insert (pair) requires GR32707	\$270.00	

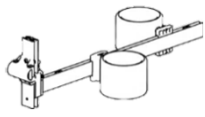
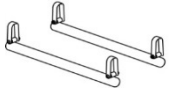
Accessories

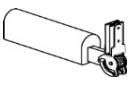
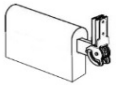
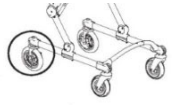
GR865-MN	Headrest Mn POSTERIOR ONLY 10" height adj requires chest support	\$600.00	
GR865	Headrest Sm, Md, Lg POSTERIOR ONLY 10" height adj requires chest support	\$600.00	
GR919-S	Lumbar Support Sm POSTERIOR ONLY 3" tall, 8" wide	\$310.00	
GR919-M	Lumbar Support Md POSTERIOR ONLY 4" tall, 9.5" wide	\$310.00	
GR918-S	Folding Seat Sm POSTERIOR ONLY 10" deep, 6" wide	\$370.00	
GR918-M	Folding Seat Md POSTERIOR ONLY 11" deep, 7" wide	\$400.00	

Accessories

Part Number	Description	Price	
GR890-MN	Padded Leg Divider Mn only 22" long	\$450.00	
GR890	Padded Leg Divider Sm, Md, Lg 24" long	\$650.00	
GR890C-S	Leg Divider Sm 21" long, cuff size 10" - 16"	\$710.00	
GR890C-M	Leg Divider Md 23" long, cuff size 14" - 20"	\$760.00	
GR890C-L	Leg Divider Lg 28" long, cuff size 18" - 26"	\$810.00	
	<u>Description:</u> Adjustable in height and stride length.		
GR810-S	Weight Bars Sm 11.5 lbs. total	\$300.00	
GR810-ML	Weight Bars Md, Lg 15 lbs. total	\$320.00	
GR946-MN	Ergonomic Saddle Mn pad L: 9" FW: 2.5" RW: 5.5" straps F: 10" R: 6"	\$400.00	
GR946-S	Ergonomic Saddle Sm pad L: 10" FW: 3" RW: 6.5" straps F: 12" R: 10"	\$400.00	
GR946-MD	Ergonomic Saddle Md pad L: 11" FW: 3.5" RW: 7" straps F: 13" R: 13"	\$420.00	
GR815-S	Abduction Saddle Sm pad W: 2.5" H: 3.5" L: 10" Overall L: 14"	\$380.00	
GR815-M	Abduction Saddle Md pad W: 3" H: 3.5" L: 12" Overall L: 16"	\$400.00	
GR815-L	Abduction Saddle Lg pad W: 3" H: 4" L: 14" Overall L: 19"	\$480.00	
	Distance between pelvic harness and saddle top hole 4.5" bottom hole 6"		
GR34429	Saddle Extension Sm 6" of extended abduction requires GR815-S	\$190.00	
GR34430	Saddle Extension Md 6" of extended abduction requires GR815-M	\$200.00	
GR34431	Saddle Extension Lg 6" of extended abduction requires GR815-L	\$210.00	
GR928	Narrow Rear Wheels Md, Lg with pedal brakes Medium In-line wheel makes the overall width 27" instead of 30" Large In-line wheel makes the overall width 28.5" instead of 31.5"	\$850.00	
GR923	Assistant Push Handle Mn, Sm, Md, Lg	\$320.00	
GRTRY-MN	Tray with Handlebar Mn ONLY	\$860.00	
GRTRY-S	Tray with Handlebar Sm ONLY	\$900.00	
GR-894	Belt for Tray	\$150.00	
GR-937-0	Handles for Tray	\$290.00	

Required

Discounts do not apply

LO

<u> </u> FREIGHT	Total order under \$50	\$12.99
	Total order under \$250	\$24.99
	Total order under \$750	\$49.99
	Total order under \$1,000	\$79.99
	Total order over \$1,000	\$119.99

Client Measurements

A Back height: _____ F Lower leg length: _____
 B Chest depth: _____ G Head height: _____
 C Chest width: _____ H Arm height: _____
 D Seat depth: _____ Age: _____
 E Seat width: _____ Weight: _____

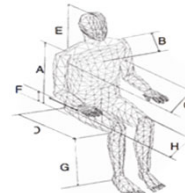

Dimensions

Measurements in Inches

Grillo	Mini	Small	Medium	Large
Max Capacity	77 lbs	99 lbs	198 lbs	242 lbs
User Height	29 - 39	35 - 53	43 - 65	59 - 75
Unit Weight	28 lbs	36 lbs	43 lbs	51 lbs
A	21 - 31	23.5 - 34	29 - 47	33 - 55
B	20 - 29.5	27 - 37.5	30 - 47	32.5 - 56
C	16.5 - 24	19 - 33	21 - 39	25 - 46
D	29	29.5	36	43.5
E	22.5	25.5	30	31.5

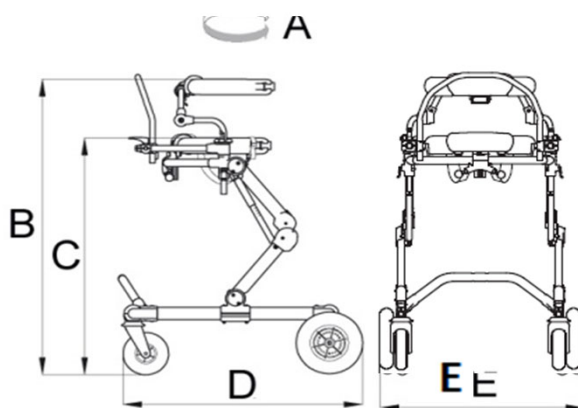

One Frame → 7 Configurations

Note: All specification and prices are subject to change without notice. Prices listed are only valid if ordering with a gait trainer. The HCPCS codes provided are not intended to be billing or legal advice, rather Innovation In Motion's interpretation of the code definitions. Use of the codes provided does not ensure coverage or payment for the item. For coverage information, verify the policy of the appropriate payer. It is recommended to contact Innovation In Motion with any questions regarding proper ordering of the chair at 1-260-665-2769.