

Super Complete

U. S. Suggested Retail Price List
Nov-21

Mini, Small, Medium, Large

Phone: 260-665-2769

Fax: 260-665-3047

Email: iim@mobility-usa.com

www.mobility-usa.com

Quote: _____

P.O. _____

Bill To

Dealer: _____ Contact: _____

Address: _____

City: _____ State: _____ Zip: _____

Phone: _____ Fax: _____

Email: _____ Mark For: _____

Ship To Same as Bill To _____

Dealer: _____ Contact: _____

Address: _____

City: _____ State: _____ Zip: _____

Phone: _____ Fax: _____

Email: _____ Mark For: _____

Grillo Features and Specifications Mini, Small, Medium, Large

- **Quick Adjustment** - Grillo adjusts easily and tool-free for user growth, transportation, or multiple patient use.
- **Easy Transport** - In just one motion, Grillo folds into a small compact unit easy to transport. No tools required.
- **Exclusively-Designed Wheels** - Grillo wheels come standard with anti-rollback, independently adjustable tension drag, and brakes. The wheels are suitable for indoor and outdoor use.
- **Chest & Pelvic Supports** - Padded and adjustable in angle, height, inclination, and circumference. The chest and pelvic supports work independently.
- **Ergonomic Harness** - The harness supports the user if necessary without generating pressure and is breathable, adjustable, and removable.
- **Measurement Bars** - allow for quick, easy, and accurate adjustment.
- **Grillo** - has the widest range of height adjustment on the market.



Grillo Frame

Part Number	Description	Price
Posterior SC - includes frame, pelvic support hardware and rings, chest support hardware and rings, ergonomic harness, horizontal bars, hand grips, directional locks, pedal parking brake		
_____ GRPSC-MN	Super Complete Posterior Grillo Mini	\$3,750.00
_____ GRPSC-S	Super Complete Posterior Grillo Small	\$3,850.00
_____ GRPSC-M	Super Complete Posterior Grillo Medium	\$4,150.00
_____ GRPSC-L	Super Complete Posterior Grillo Large	\$4,700.00

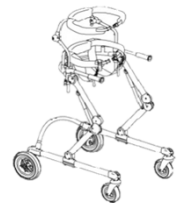

Anterior SC - includes frame, pelvic support hardware and rings, chest support hardware and rings, ergonomic harness, horizontal bars, anterior handle bar, multi axis hardware, directional locks, pedal parking brake

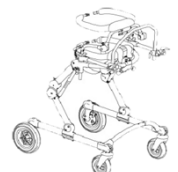

_____ GRASC-MN	Super Complete Anterior Grillo Mini	\$3,850.00
_____ GRASC-S	Super Complete Anterior Grillo Small	\$3,950.00
_____ GRASC-M	Super Complete Anterior Grillo Medium	\$4,300.00
_____ GRASC-L	Super Complete Anterior Grillo Large	\$4,850.00



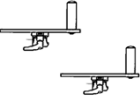
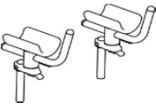

Handles

Part Number	Description	Price	
GR927-MN	Posterior Hand Grips Mn	\$110.00	
GR927	Posterior Hand Grips Sm, Md, Lg	\$110.00	
GR926-MN	Anterior Handlebar Mn requires GR-HW-MN	\$120.00	
GR926-S	Anterior Handle Bar Sm requires GR-HW	\$120.00	
GR926-M	Anterior Handle Bar Md requires GR-HW	\$170.00	
GR926-L	Anterior Handle Bar Lg requires GR-HW	\$170.00	
GR939	Ergonomic Handles Mn, Sm, Md, Lg requires GR-HW or GR-HW-MN	\$190.00	
GR-HW-MN	Multi Axis Hardware Mn	\$90.00	
GR-HW	Multi Axis Hardware Sm, Md, Lg	\$90.00	

Arm Support



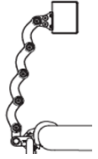

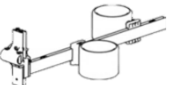

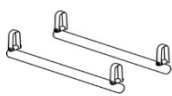

GR809-MN	Arm Supports Mn 7" long 4" wide requires GR-HW-MN	\$600.00	
GR809-S	Arm Supports Sm 6" long 3.5" wide requires GR-HW	\$700.00	
GR809-M	Arm Supports Md, Lg 7.5" long 4" wide requires GR-HW	\$750.00	
<u>Description:</u> Works with Anterior and Posterior. Adjustable in height, direction, depth, tilt, and inclination.			
GR943-MNS	Arm Straps Mn, Sm (pair)	\$50.00	
GR943-ML	Arm Straps Md, Lg (pair)	\$50.00	
GR32707	Elbow Stop Sm, Md, Lg 4"x3" padded elbow stop(pr) require GR809-Sm, Md, Lg	\$420.00	
GR50048	Elbow Stop Cover with Gel Insert (pair) requires GR32707	\$270.00	

Accessories

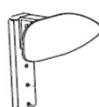
GR865-MN	Headrest Mn POSTERIOR ONLY 10" height adj requires chest support	\$600.00	
GR865	Headrest Sm, Md, Lg POSTERIOR ONLY 10" height adj requires chest support	\$600.00	
GR890-MN	Padded Leg Divider Mn 22" long	\$450.00	
GR890	Padded Leg Divider Sm, Md, Lg 24" long	\$650.00	
GR890C-S	Leg Divider Sm 21" long, cuff size 10" - 16" 8" height adjustment	\$710.00	
GR890C-M	Leg Divider Md 23" long, cuff size 14" - 20" 8" height adjustment	\$760.00	
GR890C-L	Leg Divider Lg 28" long, cuff size 18" - 26" 11" height adjustment	\$810.00	

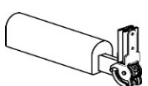
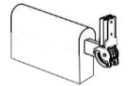
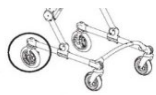
Description: Adjustable in height and stride length.

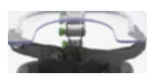
Accessories

Part Number	Description	Price	
GR810-S	Weight Bars Sm 11.5 lbs. total	\$300.00	
GR810-ML	Weight Bars Md, Lg 15 lbs. total	\$320.00	
GR918-S	Folding Seat Sm POSTERIOR ONLY 10" deep, 6" wide	\$370.00	
GR918-M	Folding Seat Md POSTERIOR ONLY 11" deep, 7" wide	\$400.00	
GR919-S	Lumbar Support Sm POSTERIOR ONLY 3" tall, 8" wide	\$310.00	
GR919-M	Lumbar Support Md POSTERIOR ONLY 4" tall, 9.5" wide	\$310.00	
GR946-MN	Ergonomic Saddle Mn pad L: 9" FW: 2.5" RW: 5.5" straps F: 10" R: 6"	\$400.00	
GR946-S	Ergonomic Saddle Sm pad L: 10" FW: 3" RW: 6.5" straps F: 12" R: 10"	\$400.00	
GR946-MD	Ergonomic Saddle Md pad L: 11" FW: 3.5" RW: 7" straps F: 13" R: 13"	\$420.00	
GR815-S	Abduction Saddle Sm pad W: 2.5" H: 3.5" L: 10" Overall L: 14"	\$380.00	
GR815-M	Abduction Saddle Md pad W: 3" H: 3.5" L: 12" Overall L: 16"	\$400.00	
GR815-L	Abduction Saddle Lg pad W: 3" H: 4" L: 14" Overall L: 19" distance between pelvic harness and saddle top hole 4.5" bottom hole 6"	\$480.00	
GR34429	Saddle Extension Sm 6" of extended abduction requires GR815-S	\$190.00	
GR34430	Saddle Extension Md 6" of extended abduction requires GR815-M	\$200.00	
GR34431	Saddle Extension Lg 6" of extended abduction requires GR815-L	\$210.00	
GR928	Narrow Rear Wheels Md, Lg with pedal brakes In-line wheel makes the overall Medium width 27" instead of 30" In-line wheel makes the overall Large width 28.5" instead of 31.5"	\$850.00	
GR923	Assistant Push Handle Mn, Sm, Md, Lg	\$320.00	
GRTRY-MN	Tray with Handlebar Mn ONLY	\$860.00	
GRTRY-S	Tray with Handlebar Sm ONLY	\$900.00	
GR-894	Belt for Tray	\$150.00	
GR-937-0	Handles for Tray	\$290.00	

Required

Discounts do not apply

LO

FREIGHT	Total order under \$50	\$12.99
	Total order under \$250	\$24.99
	Total order under \$750	\$49.99
	Total order under \$1,000	\$79.99
	Total order over \$1,000	\$119.99

Client Measurements

A Back height: _____ F Lower leg length: _____
 B Chest depth: _____ G Head height: _____
 C Chest width: _____ H Arm height: _____
 D Seat depth: _____ Age: _____
 E Seat width: _____ Weight: _____

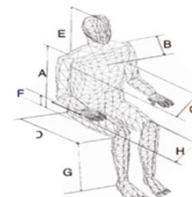

Dimensions

Measurements in Inches

Grillo	Mini	Small	Medium	Large
Max Capacity	77 lbs	99 lbs	198 lbs	242 lbs
User Height	29 - 39	35 - 53	43 - 65	59 - 75
Unit Weight	28 lbs	36 lbs	43 lbs	51 lbs
A	21 - 31	23.5 - 34	29 - 47	33 - 55
B	20 - 29.5	27 - 37.5	30 - 47	32.5 - 56
C	16.5 - 24	19 - 33	21 - 39	25 - 46
D	29	29.5	36	43.5
E	22.5	25.5	30	31.5

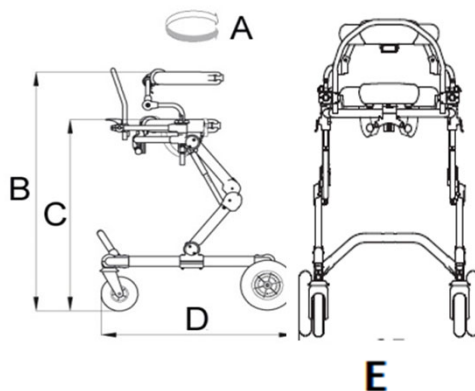

One Frame → 7 Configurations

Grillo Small & Medium

Note: All specification and prices are subject to change without notice. Prices listed are only valid if ordering with a gait trainer. The HCPCS codes provided are not intended to be billing or legal advice, rather Innovation In Motion's interpretation of the code definitions. Use of the codes provided does not ensure coverage or payment for the item. For coverage information, verify the policy of the appropriate payer. It is recommended to contact Innovation In Motion with any questions regarding proper ordering of the chair at 1-260-665-2769.

Client:

PO:

GRILLO

Client:

PO:

GRILLO

Client:

PO:

GRILLO