



By Ormesa



201 Growth Parkway Angola, IN 46703

U. S. Suggested Retail Price List

Phone: 260-665-2769

Nov-21

Fax: 260-665-3047

Email: iim@mobility-usa.com

www.mobility-usa.com

Quote: _____

P.O. _____

Bill To

Dealer: _____ Contact: _____

Address: _____

City: _____ State: _____ Zip: _____

Phone: _____ Fax: _____

Email: _____ Mark For: _____

Ship To Same as Bill To _____

Dealer: _____ Contact: _____

Address: _____

City: _____ State: _____ Zip: _____

Phone: _____ Fax: _____

Email: _____ Mark For: _____

Novus Features and Specifications

- **Frame** - foldable aluminum, with non-toxic epoxy black powders
- **Upholstery** - padded, ergonomic & removable; wear, water and fire proof fabric; designed to make the change of accessories easier without causing trouble to the child while seated
- **Backrest** - adjustable in height and tilt
- **Seat Bottom** - adjustable in width and depth
- **Legrest** - adjustable in tilt, with a quick release mechanism; flip-up footrest adjustable in tilt
- **Wheels** - snap-on, sliding on ball bearings; front wheel 7" and puncture-proof rear wheel 12" with independent drum brakes

Novus

Part Number	Description	Price
____ NN-2	Novus 2	\$3,600.00
____ NN-3	Novus 3	\$3,700.00
____ NN-4	Novus 4	\$3,800.00









Footrest Options





____ 827	Foot Straps 8"-11"	\$80.00
____ 827A	Foot Straps 11"-14"	\$80.00
____ 817-S	Leg Straps 2	\$160.00
____ 817-M	Leg Straps 3 & 4	\$160.00
____ NN892-2	Padded Footplate Covering 2	\$110.00
____ NN892-3	Padded Footplate Covering 3	\$110.00
____ NN892-4	Padded Footplate Covering 4	\$110.00



Positioning Options

Part Number	Description	Price	
____ NN838-2	Adjustable Lateral Supports 2	\$280.00	
____ NN838-3	Adjustable Lateral Supports 3	\$280.00	
____ NN838-4	Adjustable Lateral Supports 4	\$280.00	
____ 853-S	Vest Harness 2	\$190.00	
____ 853-M	Vest Harness 3 & 4	\$190.00	
____ 894-S	45° Pelvic Belt 2	\$100.00	
____ 894-M	45° Pelvic Belt 3 & 4	\$100.00	
____ 906-S	Five Point Harness 2	\$140.00	
____ 906-M	Five Point Harness 3 & 4	\$140.00	
____ NN868-2	Wrappable and Flexible Trunk Supports 2	\$470.00	
____ NN868-3	Wrappable and Flexible Trunk Supports 3 & 4	\$470.00	
____ NB834-S	Padded Abduction Block 2	\$160.00	
____ NB834-M	Padded Abduction Block 3 & 4	\$160.00	
____ NN852-2	Headrest with Parietal Supports 2 & 3	\$320.00	
____ NN852-4	Headrest with Parietal Supports 4	\$320.00	
____ NN863-2	Headrest with Occipital-Parietal Supports 2 & 3 requires NN863-HW	\$320.00	
____ NN863-4	Headrest with Occipital-Parietal Supports 4 requires NN863-HW	\$320.00	
____ NN863-HW	Headrest Hardware	\$290.00	

Accessories

____ NN812	Wheel directional locks	\$180.00	
____ 818-S	Black Thermal Cover 2	\$400.00	
____ 818-M	Black Thermal Cover 3 & 4	\$400.00	
____ NN819-2	Black Canopy 2 & 3 requires NN819-HW	\$330.00	
____ NN819-4	Black Canopy 4 requires NN819-HW	\$330.00	
____ NN819-HW	Canopy Hardware	\$140.00	
____ NN825-2	Black Rain Cover 2 & 3 requires 819	\$190.00	
____ NN825-4	Black Rain Cover 4 requires 819	\$190.00	

Accessories Continued

Part Number	Description	Price	
____ NN839-2	Front Handle 2	\$280.00	
____ NN839-3	Front Handle 3	\$280.00	
____ NN839-4	Front Handle 4	\$280.00	
____ NN824-2	Transparent Table with Edge & Hollow 2 requires NN824-HW	\$220.00	
____ NN824-3	Transparent Table with Edge & Hollow 3 requires NN824-HW	\$220.00	
____ NN824-4	Transparent Table with Edge & Hollow 4 requires NN824-HW	\$220.00	
____ NN824-HW	Adjustable and Removable Table Hardware	\$170.00	
____ NN844	Side Protecting Covers	\$170.00	
____ 858-M	Medical Necessity Basket Not compatible with NB927	\$140.00	
____ NN927-2	Vent Tray 2 Not compatible with 858	\$710.00	
____ NN927-3	Vent Tray 3 & 4 Not compatible with 858	\$710.00	
____ 891	Tie Down Hooks	\$300.00	
	Intended for forward-facing transport of the pushchair in a motor vehicle. Conforms with ISO 7176/19 and ANSI RESNA WC/19.		
____ 922	Bottle Holder	\$50.00	

Required

Discounts do not apply

____ FREIGHT	Total order under \$50	\$12.99
	Total order under \$250	\$24.99
	Total order under \$750	\$49.99
	Total order under \$1,000	\$79.99
	Total order over \$1,000	\$119.99

Client Measurements

A Back height: _____ F Lower leg length: _____
 B Chest depth: _____ G Head height: _____
 C Chest width: _____ H Arm height: _____
 D Seat depth: _____ Age: _____
 E Seat width: _____ Weight: _____

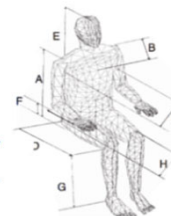

Dimensions

Measurements in Inches

Novus	Size 2	Size 3	Size 4
Max Capacity	99 lbs	121 lbs	143 lbs
User Height	49 - 57	51 - 61	57 - 66.5
Unit Weight	43 lbs	46 lbs	49 lbs
A	16	17	18
B	8 - 12	9.5 - 13	11 - 15
C	12 - 14	14 - 16	15 - 18
D	10.5 - 14.5	12 - 16	12 - 17
E	25.5 - 28	28 - 31.5	29.5 - 32
F	40.5	41.5	42
G	23.5	25	26
H	34	36.5	38
M	16	16	16.5
N	40	41	43
O	22.5	23.5	24.5
P	32.5	33	35.5

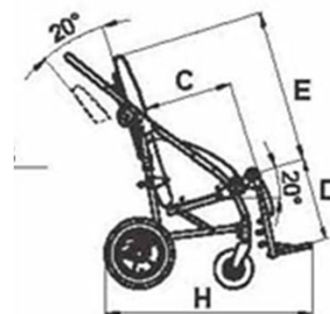
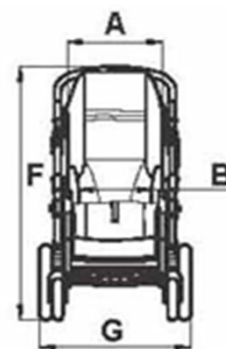

Note: All specification and prices are subject to change without notice. Prices listed are only valid if ordering with a stroller. The HCPCS codes provided are not intended to be billing or legal advice, rather Innovation In Motion's interpretation of the code definitions. Use of the codes provided does not ensure coverage or payment for the item. For coverage information, verify the policy of the appropriate payer. It is recommended to contact Innovation In Motion with any questions regarding proper ordering of the chair at 1-260-665-2769.