

Super Complete

U. S. Suggested Retail Price List
Nov-19

Mini, Small, Medium, Large

Phone: 260-665-2769

Fax: 260-665-3047

Email: iim@mobility-usa.com

www.mobility-usa.com

Quote: _____

P.O. _____

Bill To

Dealer: _____ Contact: _____

Address: _____

City: _____ State: _____ Zip: _____

Phone: _____ Fax: _____

Email: _____ Mark For: _____

Ship To

Same as Bill To _____

Dealer: _____ Contact: _____

Address: _____

City: _____ State: _____ Zip: _____

Phone: _____ Fax: _____

Email: _____ Mark For: _____

Grillo Features and Specifications Mini, Small, Medium, Large

- **Quick Adjustment** - Grillo adjusts easily and tool-free for user growth, transportation, or multiple patient use.
- **Easy Transport** - In just one motion, Grillo folds into a small compact unit easy to transport. No tools required.
- **Exclusively-Designed Wheels** - Grillo wheels come standard with anti-rollback, independently adjustable tension drag, and brakes. The wheels are suitable for indoor and outdoor use.
- **Chest & Pelvic Supports** - Padded and adjustable in angle, height, inclination, and circumference. The chest and pelvic supports work independently.
- **Ergonomic Harness** - The harness supports the user if necessary without generating pressure and is breathable, adjustable, and removable.
- **Measurement Bars** - allow for quick, easy, and accurate adjustment.
- **Grillo** - has the widest range of height adjustment on the market.



Grillo Frame

Part Number	Description	Price
Posterior SC - includes frame, pelvic support, ergonomic harness, chest support, horizontal bars, hand grips, directional locks		
_____ GRPSC-MN	Super Complete Posterior Grillo Mini	\$3,400.00
_____ GRPSC-S	Super Complete Posterior Grillo Small	\$3,500.00
_____ GRPSC-M	Super Complete Posterior Grillo Medium	\$3,800.00
_____ GRPSC-L	Super Complete Posterior Grillo Large	\$4,300.00
Anterior SC - includes frame, pelvic support, ergonomic harness, chest support, horizontal bars, multi axis hardware, handle bar, directional locks		
_____ GRASC-MN	Super Complete Anterior Grillo Mini	\$3,500.00
_____ GRASC-S	Super Complete Anterior Grillo Small	\$3,625.00
_____ GRASC-M	Super Complete Anterior Grillo Medium	\$3,950.00
_____ GRASC-L	Super Complete Anterior Grillo Large	\$4,475.00

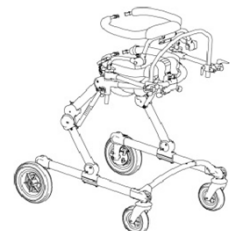

Handles

Part Number	Description	Price
_____ GR927-MN	Posterior Hand Grips Mn	\$50.00
_____ GR927	Posterior Hand Grips Sm, Md, Lg	\$50.00
_____ GR926-MN	Anterior Handlebar Mn requires GR-HW-MN	\$100.00
_____ GR926-S	Anterior Handle Bar Sm requires GR-HW	\$100.00
_____ GR926-M	Anterior Handle Bar Md requires GR-HW	\$125.00
_____ GR926-L	Anterior Handle Bar Lg requires GR-HW	\$150.00
_____ GR939	Ergonomic Handles Mn, Sm, Md, Lg requires GR-HW	\$125.00
_____ GR-HW-MN	Multi Axis Hardware Mn	\$75.00
_____ GR-HW	Multi Axis Hardware Sm, Md, Lg	\$75.00

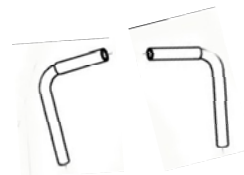
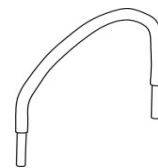
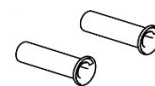
**Arm Support**

_____ GR809-MN	Arm Supports Mn 7" long 4" wide requires GR-HW-MN	\$550.00
_____ GR809-S	Arm Supports Sm 6" long 3.5" wide requires GR-HW	\$600.00
_____ GR809-M	Arm Supports Md 7.5" long 4" wide requires GR-HW	\$650.00
_____ GR809-L	Arm Supports Lg 8" long 4" wide requires GR-HW	\$650.00
<u>Description:</u> Works with Anterior and Posterior. Adjustable in height, direction, depth, tilt, and inclination.		
_____ GR943-MNS	Arm Straps Mn, Sm (pair)	\$40.00
_____ GR943-ML	Arm Straps Md, Lg (pair)	\$40.00
_____ GR32707	Elbow Stop Sm, Md, Lg 4"x3" padded elbow stop (pair) requires GR809	\$385.00
_____ GR50048	Elbow Stop Cover with Gel Insert (pair) requires GR32707	\$250.00

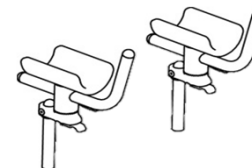
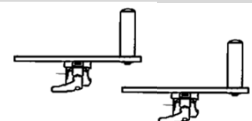

**Accessories**

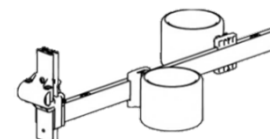
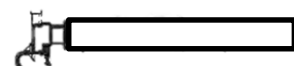
_____ GR865	Headrest Sm, Md, Lg POSTERIOR ONLY 10" height adjustment Requires Chest Support	\$550.00
_____ GR890-MN	Padded Leg Divider Mn 22" long	\$400.00
_____ GR890	Padded Leg Divider Sm, Md, Lg 24" long	\$600.00
_____ GR890C-S	Leg Divider Sm 21" long, cuff size 10" - 16"	\$650.00
_____ GR890C-M	Leg Divider Md 23" long, cuff size 14" - 20"	\$700.00
_____ GR890C-L	Leg Divider Lg 28" long, cuff size 18" - 26"	\$750.00

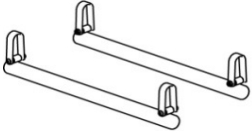
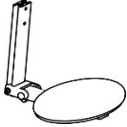
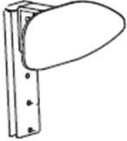
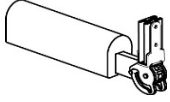
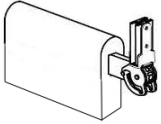

Description: Adjustable in height and stride length.

Accessories

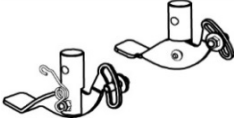
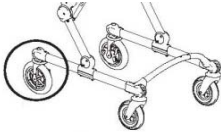
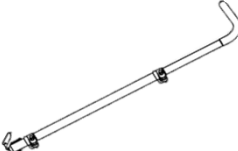
Part Number	Description	Price	
_____ GR810-S	Weight Bars Sm 11.5 lbs. total	\$275.00	
_____ GR810-ML	Weight Bars Md, Lg 15 lbs. total	\$295.00	
_____ GR918-S	Folding Seat Sm POSTERIOR ONLY 10" deep, 6" wide	\$335.00	
_____ GR918-M	Folding Seat Md POSTERIOR ONLY 11" deep, 7" wide	\$365.00	
_____ GR919-S	Lumbar Support Sm POSTERIOR ONLY 3" tall, 8" wide	\$280.00	
_____ GR919-M	Lumbar Support Md POSTERIOR ONLY 4" tall, 9.5" wide	\$280.00	
_____ GR815-S	Abduction Saddle Sm pad W: 2.5" H: 3.5" L: 10" Overall L: 14"	\$345.00	
_____ GR815-M	Abduction Saddle Md pad W: 3" H: 3.5" L: 12" Overall L: 16"	\$365.00	
_____ GR815-L	Abduction Saddle Lg pad W: 3" H: 4" L: 14" Overall L: 19" distance between pelvic harness and saddle top hole 4.5" bottom hole 6"	\$445.00	
_____ GR34429	Saddle Extension Sm 6" of extended abduction requires GR815-S	\$175.00	
_____ GR34430	Saddle Extension Md 6" of extended abduction requires GR815-M	\$185.00	
_____ GR34431	Saddle Extension Lg 6" of extended abduction requires GR815-L	\$195.00	
_____ GR929-MN	Pedal Parking Brakes Mn Comes attached to wheel	\$275.00	
_____ GR929	Pedal Parking Brakes Sm, Md, Lg	\$275.00	
_____ GR928	Narrow Rear Wheels Md, Lg with pedal brakes In-line wheel makes the overall Medium width 27" instead of 30" In-line wheel makes the overall Large width 28.5" instead of 31.5"	\$675.00	
_____ GR923	Assistant Push Handle Mn, Sm, Md, Lg	\$290.00	

Client Measurements

A Back height: _____ F Lower leg length: _____
 B Chest depth: _____ G Head height: _____
 C Chest width: _____ H Arm height: _____
 D Seat depth: _____ Age: _____
 E Seat width: _____ Weight: _____

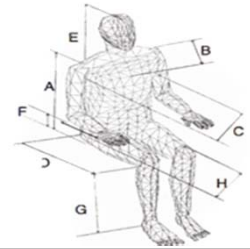

Dimensions

Measurements in Inches

Grillo	Mini	Small	Medium	Large
Max Capacity	77 lbs	99 lbs	198 lbs	242 lbs
User Height	29 - 39	35 - 53	43 - 65	59 - 75
Unit Weight	28 lbs	36 lbs	43 lbs	51 lbs
A	21 - 31	23.5 - 34	29 - 47	33 - 55
B	20 - 29.5	27 - 37.5	30 - 47	32.5 - 56
C	16.5 - 24	19 - 33	21 - 39	25 - 46
D	29	29.5	36	43.5
E	22.5	25.5	30	31.5

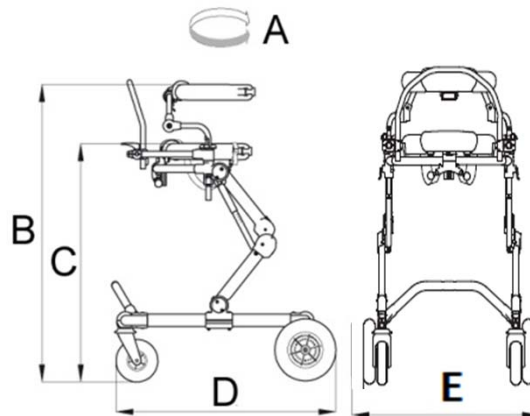

One Frame → 7 Configurations

Grillo Small & Medium

Note: All specification and prices are subject to change without notice. Prices listed are only valid if ordering with a gait trainer. The HCPCS codes provided are not intended to be billing or legal advice, rather Innovation In Motion's interpretation of the code definitions. Use of the codes provided does not ensure coverage or payment for the item. For coverage information, verify the policy of the appropriate payer. It is recommended to contact Innovation In Motion with any questions regarding proper ordering of the chair at 1-260-665-2769.