



U. S. Suggested Retail Price List
Dec-19

Phone: 260-665-2769

Fax: 260-665-3047

Email: iim@mobility-usa.com

www.mobility-usa.com

Quote: _____

P.O. _____

Bill To

Dealer: _____ Contact: _____

Address: _____

City: _____ State: _____ Zip: _____

Phone: _____ Fax: _____

Email: _____ Mark For: _____

Ship To Same as Bill To _____

Dealer: _____ Contact: _____

Address: _____

City: _____ State: _____ Zip: _____

Phone: _____ Fax: _____

Email: _____ Mark For: _____

New Bug Features and Specifications

- **Seat** - can be used as a floor sitter, width and depth adjustable by 4" in each direction, small can be forward or reverse facing
- **Tilt** - incorporated in the seat 40°, easily adjusts with levers located on seat back
- **Headrest** - incorporated into the backrest so that the child always has a support
- **Backrest** - slightly contoured, can recline 35° (hinge coincides with child's center of gravity) height adjustable 4" with slots for accessories
- **Elevating Legrest** - push button adjustable, footrest is height and angle adjustable
- **Base** - black powder coated aluminum with an angle adjustable push-handle

New BUG Seat - includes: seat back, seat pan, tilt, and recline.

Part Number	Description	Price	HCPCS
____ NBS	New BUG Small	\$1,100.00	E1399
____ NBM	New BUG Medium	\$1,200.00	E1399
____ NBREC	Reclining Backrest required	\$400.00	E1014



Outdoor Base Options

____ NB869-S	4-Wheel Base Sm	\$1,900.00	E1238
____ NB869-M	4-Wheel Base Md	\$2,000.00	E1238
____ 891	Set of Tie Down Hooks (Only available with NB869)	\$275.00	K0108

Intended for forward-facing transport of the pushchair in a motor vehicle. Conforms with ISO 7176/19 and ANSI RESNA WC/19.













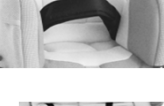



____ NB856-S	Hi-Low Feeding Base Sm	\$1,850.00	E1399
____ NB856-M	Hi-Low Feeding Base Md	\$1,950.00	E1399
____ NB850-S	Floor Base Sm	\$660.00	E1399
____ NB850-M	Floor Base Md	\$710.00	E1399

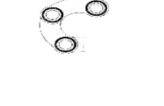

Colors		This price is only valid when purchasing a seat unit.				
Part Number	Description	Price				
NBLPB-S/NBLPB-M	Light Grey with Pink & Blue accent	\$10.00				
NBDPB-S/NBDPB-M	Dark Grey with Pink & Blue accent	\$10.00				
NBLGB-S/NBLGB-M	Light Grey with Green & Blue accent	\$10.00				
NBDGB-S/NBDGB-M	Dark Grey with Green & Blue accent	\$10.00				
Footrest Options		Footplate and Hardware Required Parts				
NB810-S	Angle Adjustable Flip Up Footplate Sm	requires NB810-HW	\$125.00	K0040		
NB810-M	Angle Adjustable Flip Up Footplate Md	requires NB810-HW	\$125.00	K0040		
NB810-HW	Footplate Hardware and Adjustment Tool		\$125.00	E1028		
Footrest Accessories						
NB811	Calf Strap		\$50.00	E0995		
827	Foot Strap 8-11"		\$70.00	E0951		
827A	Foot Strap 11-14"		\$70.00	E0951		
NB892-S	Padded Foot Plate Sm		\$100.00	K0108		
NB892-M	Padded Foot Plate Md		\$100.00	K0108		
Hip Guide Options		Hip Guides and Hardware Required Parts				
<u>Size Small</u>						
NB815-L-S	Left Hip Guide width & angle adj armrest & upholstery	requires NB815-HW	\$60.00	E0956		
NB815-R-S	Right Hip Guide width & angle adj armrest & upholstery	requires NB815-HW	\$60.00	E0956		
NB815-L-HW/R-HW	Hardware for Hip Guide and Arm Rest		\$60.00	E1028		
<u>Size Medium</u>						
NB815-L-M	Left Hip Guide width & angle adj armrest & upholstery	requires NB815-HW	\$60.00	E0956		
NB815-R-M	Right Hip Guide width & angle adj armrest & upholstery	requires NB815-HW	\$60.00	E0956		
NB815-L-HW/R-HW	Hardware for Hip Guide and Arm Rest		\$60.00	E1028		

Positioning Options

Part Number	Description	Price	HCPCS	
817-S	Leg Straps Sm	\$135.00	K0038	
817-M	Leg Straps Md	\$135.00	K0038	
NB920-S	4 Point Pelvic Belt Sm	\$195.00	E0978	
NB920-M	4 Point Pelvic Belt Md	\$195.00	E0978	
894-S	45° Pelvic Belt Sm	\$95.00	E0978	
894-M	45° Pelvic Belt Md	\$95.00	E0978	
906-S	5 Point Harness Sm	\$130.00	E0960	
906-M	5 Point Harness Md	\$130.00	E0960	
NB903-S	5 Point Vest Harness Sm	\$295.00	E0960	
NB903-M	5 Point Vest Harness Md	\$295.00	E0960	
853-S	Vest Harness Sm	\$175.00	E0960	
853-M	Vest Harness Md	\$175.00	E0960	
NB868-S	Wrappable & Flexible Trunk Support Sm height & depth adjustable	\$430.00	E0956	
NB868-M	Wrappable & Flexible Truck Support Md height & depth adjustable	\$430.00	E0956	
NB838-S	Lateral Pads Sm requires NB838-HW	\$100.00	E0956	
NB838-M	Lateral Pads Md requires NB838-HW	\$100.00	E0956	
NB838-HW	Lateral Hardware height and depth adjustable	\$150.00	E1028	
NB834-S	Padded Abduction Block w/ Hardware Sm depth adjustable	\$140.00	E0957	
NB834-M	Padded Abduction Block w/ Hardware Md depth adjustable	\$140.00	E0957	
NB852-S	Headrest w/ Parietal Supports Sm fixed, height adjustable	\$290.00	E0955	
NB852-M	Headrest w/ Parietal Supports Md fixed, height adjustable	\$290.00	E0955	
NB863-S	Headrest w/ Occipital-Parietal Supports Sm requires NB863-HW	\$290.00	E0955	
NB863-M	Headrest w/ Occipital-Parietal Supports Md requires NB863-HW	\$290.00	E0955	
NB863-HW	Multi Axis Hardware - angle and depth adjustable	\$265.00	E1028	
NB942-S	Ergonomic Headrest Sm requires NB942-HW	\$290.00	E0955	
NB942-M	Ergonomic Headrest Md requires NB942-HW	\$290.00	E0955	
NB942-HW	Multi Axis Hardware - angle and depth adjustable	\$170.00	E1028	

Accessories

Part Number	Description	Price	HCPCS	
NB819P-S	Black Retractable Canopy w/ Pink accent Sm <small>requires NB819-HW</small>	\$295.00	K0108	
NB819P-M	Black Retractable Canopy w/ Pink accent Md <small>requires NB819-HW</small>	\$295.00	K0108	
NB819G-S	Black Retractable Canopy w/ Green accent Sm <small>requires NB819-HW</small>	\$295.00	K0108	
NB819G-M	Black Retractable Canopy w/ Green accent Md <small>requires NB819-HW</small>	\$295.00	K0108	
NB819-HW	Canopy Hardware Canopy comes with front & rear view window	\$95.00	E1028	
NB825-S	Black Rain Cover Sm <small>requires NB819</small>	\$140.00	K0108	
NB825-M	Black Rain Cover Md <small>requires NB819</small>	\$140.00	K0108	
NB824-S	Transparent Table with Edge & Hollow Sm <small>requires NB824-HW</small>	\$240.00	E0950	
NB824-M	Transparent Table with Edge & Hollow Md <small>requires NB824-HW</small>	\$240.00	E0950	
NB824-HW	Adjustable and Removable Table Hardware	\$100.00	E1028	
NB824B-S	Wide Tray for Hi-Low Base Sm <small>requires NB824-HW</small>	\$240.00	E0950	
NB824B-M	Wide Tray for Hi-Low Base Md <small>requires NB824-HW</small>	\$240.00	E0950	
NB824-HW	Adjustable and Removable Table Hardware	\$100.00	E1028	
NB839-S	Front Handle Sm	\$200.00	K0108	
NB839-M	Front Handle Md	\$200.00	K0108	
818-S	Black Thermal Cover Sm	\$365.00	K0108	
818-M	Black Thermal Cover Md	\$365.00	K0108	
858-S	Medical Necessity Basket Sm <small>Not compatible with NB927 or NB935</small>	\$125.00	K0108	
858-M	Medical Necessity Basket Md <small>Not compatible with NB927 or NB935</small>	\$125.00	K0108	
NB927-S	Vent Tray Sm <small>Not compatible with 858</small>	\$650.00	E1029	
NB927-M	Vent Tray Md <small>Not compatible with 858</small>	\$650.00	E1029	
922	Water Bottle Holder	\$45.00	K0108	
NB935-S	Oxygen Bottle Holder Sm <small>Not compatible with 858</small>	\$250.00	E2208	
NB935-M	Oxygen Bottle Holder Md <small>Not compatible with 858</small>	\$250.00	E2208	
NB-IV	IV Pole	\$495.00	K0108	

Client Measurements:

A Back height: _____ F Lower leg length: _____
 B Chest depth: _____ G Head height: _____
 C Chest width: _____ H Arm height: _____
 D Seat depth: _____ Age: _____
 E Seat width: _____ Weight: _____

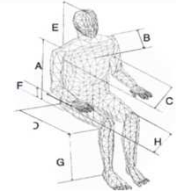

DIMENSIONS

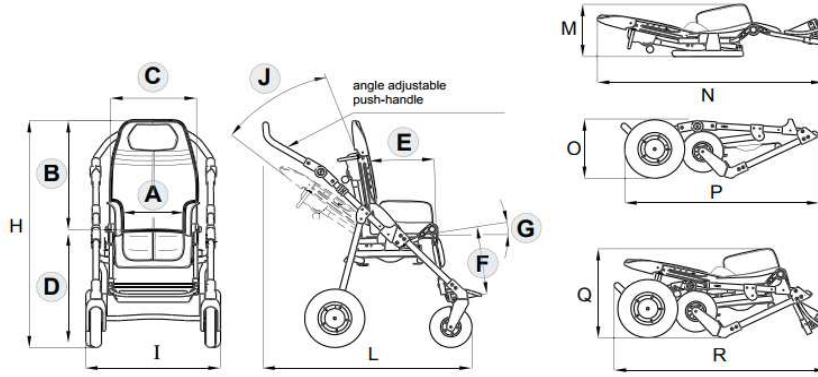

Measurements in Inches

Seat & Bases	MAX LOAD	A	B	C	D	E	F	G	J	H	I	L	M	N	O	P	Q	R	FRAME WEIGHT	SEAT WEIGHT	TOTAL WEIGHT
Sm 4 wheel	77 lbs	8 - 11	20 - 24	14.5	20.5	8 - 12	5 - 12	0° - 35°	35°	41 - 45	22.5	26 - 37	11.5	34.5	11.5	32	17	32	21	19	40
Md 4 wheel	99 lbs	10 - 14	24 - 30	17	21.5	12 - 16	12 - 16	0° - 25°	40°	45 - 51	24.5	32 - 42	13.5	44	14	36	20.5	37	23	25	48
Sm Hi/Low	77 lbs	8 - 11	20 - 24	14.5	18.5 - 29	8 - 12	5 - 12	0° - 35°	35°	39 - 53	22	14 - 24	31	16	9	N/A	N/A	N/A	32	19	51
Md Hi/Low	99 lbs	10 - 14	24 - 30	17	18.5 - 29	12 - 16	12 - 16	0° - 25°	40°	42 - 58	24	14 - 24	33	18	13	N/A	N/A	N/A	34	25	59
Sm floor base	77 lbs	8 - 11	20 - 24	14.5	6.5	8 - 12	5 - 12	0° - 35°	35°	27 - 31	18	2.5	24	16	9	N/A	N/A	N/A	10	19	29
Md floor base	99 lbs	10 - 14	24 - 30	17	6.5	12 - 16	12 - 16	0° - 25°	40°	30 - 36	20	2.5	25	18	11	N/A	N/A	N/A	12	25	37

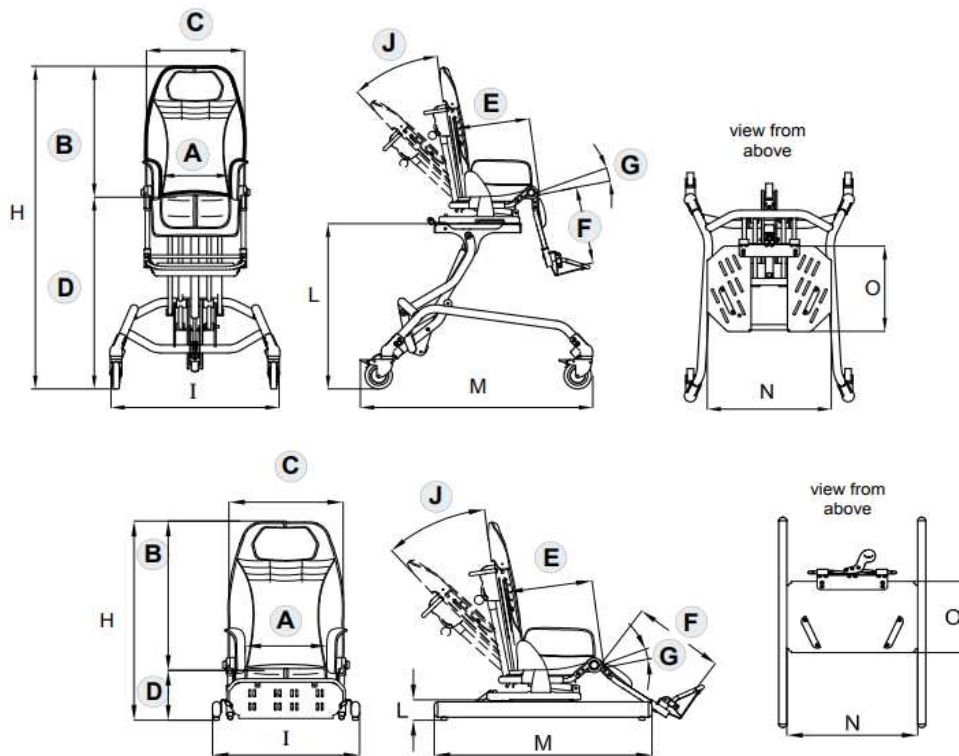

Note: All specification and prices are subject to change without notice. Prices listed are only valid if ordering with a base. The HCPCS codes provided are not intended to be billing or legal advice, rather Innovation In Motion's interpretation of the code definitions. Use of the codes provided does not ensure coverage or payment for the item. For coverage information, verify the policy of the appropriate payer. It is recommended to contact Innovation In Motion with any questions regarding proper ordering of the chair at 1-260-665-2769.